

G series

Slide switches - telecom grade

Distinctive features and specifications

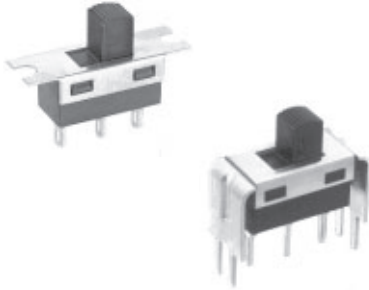

- Panel and PC mount models
- 6 actuator lengths
- Wide variety of contact materials

ELECTRICAL SPECIFICATIONS

- Max. current/voltage rating with resistive load :
 - silver contacts (codes 1 or 2) : 2A 250VAC - 4A 125VAC - 3A 30VDC
 - gold plated brass contacts (code 0) : 0,4VA 20VAC or DC max.
- Initial contact resistance : 10 mΩ
- Insulation resistance : 1.000 MΩ min.
- Dielectric strength : 1.000 Vrms 50 Hz min.
- Electrical life with resistive load :
 - silver contacts (codes 1 or 2) : 2 positions : 40.000 cycles
 - 3 positions : 20.000 cycles
 - gold plated brass contacts (code 0) : 60.000 cycles (0,4VA max.)

MATERIALS

- Case : PES
- Actuator : polyamide, glass filled
- Cover : stainless steel
- Contacts
 - 0 : brass, gold plated
 - 1 : silver
 - 2 : silver, gold plated
 - 5 : special contact, lower rating, minimum quantity : consult factory
- Terminal seal : epoxy

GENERAL SPECIFICATIONS

- Travel : 2,20 mm (.086), except actuator N on SP model : 2,60 mm (.102)
- Operating temperature : -30°C to +85°C
- Recommended soldering : 300°C 5 sec. max.

G series

Slide switches - telecom grade

Overview

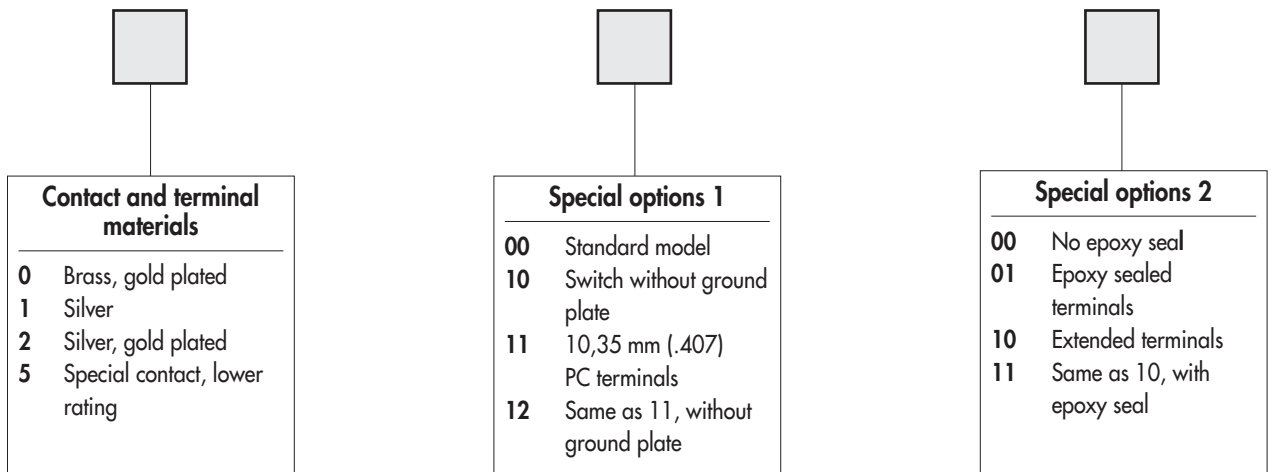
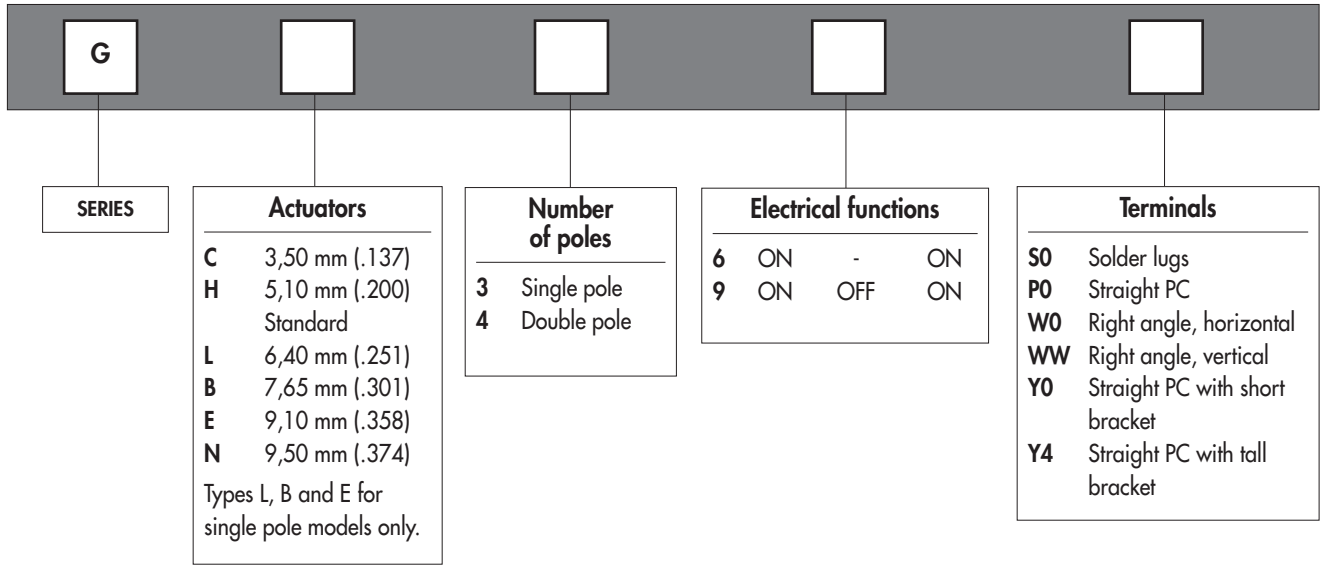

ABOUT THIS SERIES

On the following pages, you will find successively :

- model structure of switches
- options in the same order as in above chart

Dimensions : first dimensions are in mm while inches are shown as bracketted numbers.



NOTICE : please note that not all combinations of above numbers are available. Refer to the following pages for further information.



Packaging unit : 100 pieces for SP solder lug (S0) and straight terminal (P0) models. 50 pieces for other models.

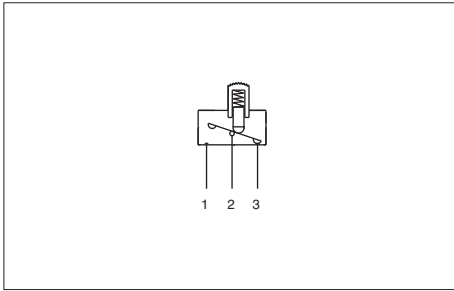

- Solder lug, straight PC or right angle terminals
- Single and double pole configurations

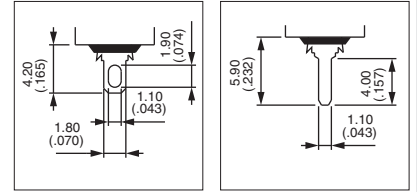

MODEL STRUCTURE

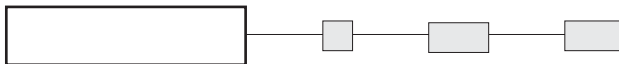

Shown with standard actuator (type H)

Solder lug terminals



Single pole	Double pole	ON	-	ON
GH36S0	GH46S0	ON	-	ON
GH39S0	GH49S0	ON	OFF	ON

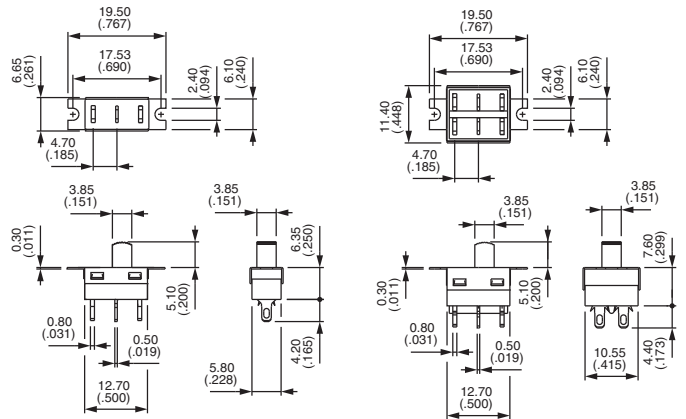

Order with epoxy sealed terminals (option 01).

Straight PC terminals



Single pole	Double pole	ON	-	ON
GH36P0	GH46P0	ON	-	ON
GH39P0	GH49P0	ON	OFF	ON

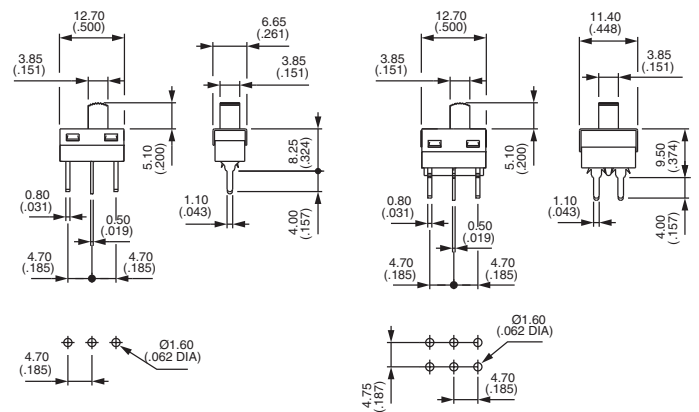

Right angle terminals - horizontal



Single pole	Double pole	ON	-	ON
GH36W0	GH46W0	ON	-	ON
GH39W0	GH49W0	ON	OFF	ON

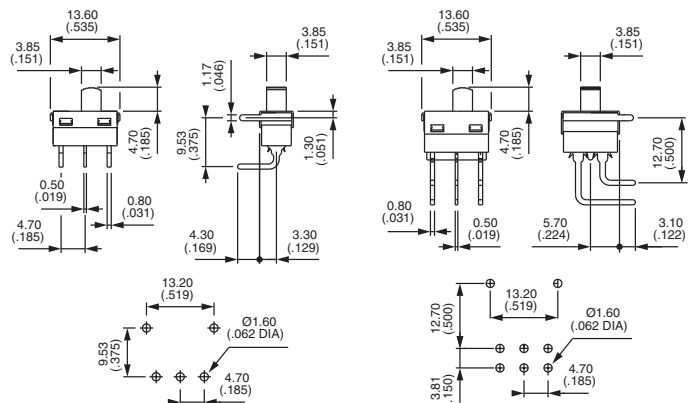

G series

Slide switches - telecom grade



Right angle terminals - vertical



Single pole	Double pole	ON	-	ON
GH36WW	GH46WW	ON	-	ON
GH39WW	GH49WW	ON	OFF	ON

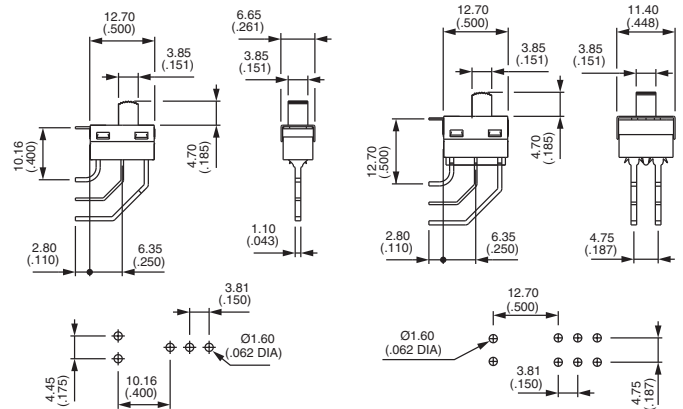

Straight PC terminals - short bracket : Y0

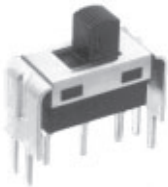

Single pole	Double pole	ON	-	ON
GH36Y0	GH46Y0	ON	-	ON
GH39Y0	GH49Y0	ON	OFF	ON

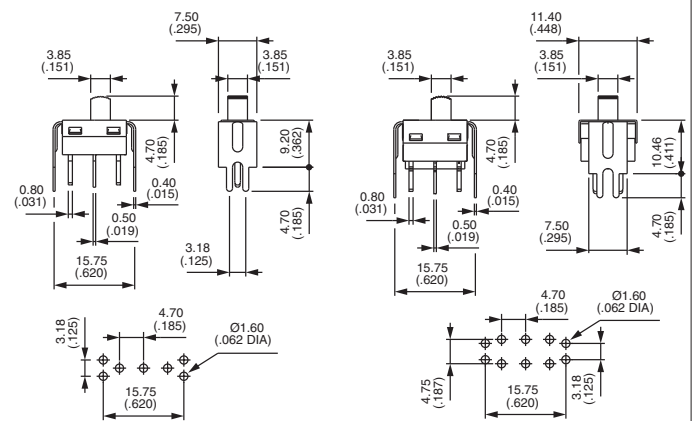

Straight PC terminals - tall bracket : Y4



Single pole	Double pole	ON	-	ON
GH36Y4	GH46Y4	ON	-	ON
GH39Y4	GH49Y4	ON	OFF	ON

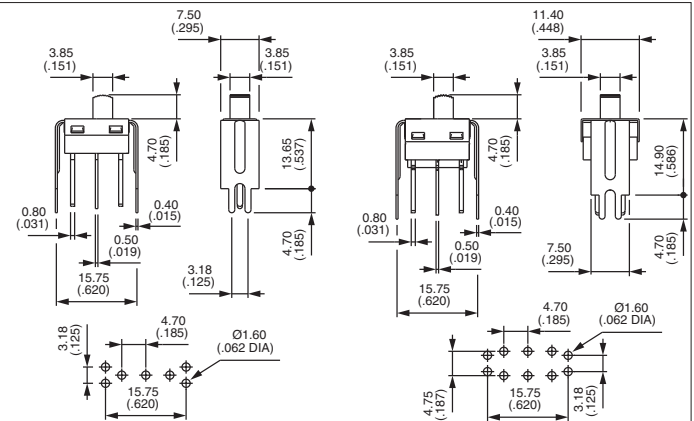

PANEL CUT-OUT

Solder lug model

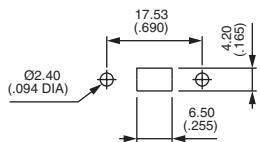

PCB MOUNTING

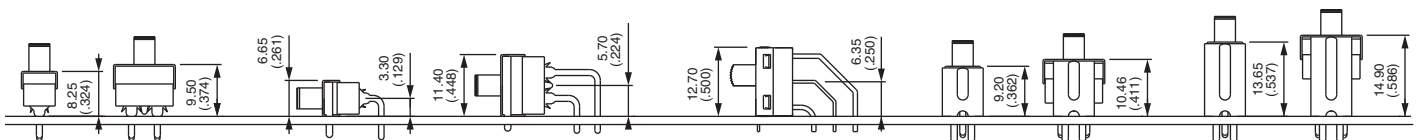



G series

Slide switches - telecom grade

ACTUATORS

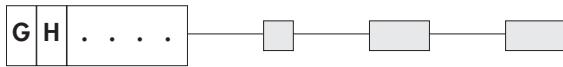

Replace second digit (H) of basic model number with one of the codes below.



Dimensions below are for solder lug (SO) and straight terminals (PO) models.
For other models (WO - WW - Y0 - Y4), height is less 0,4 mm (.015).

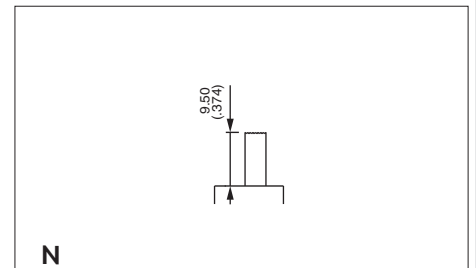
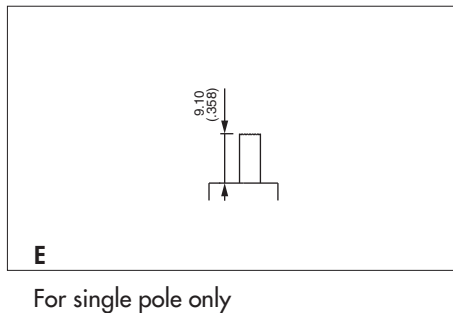
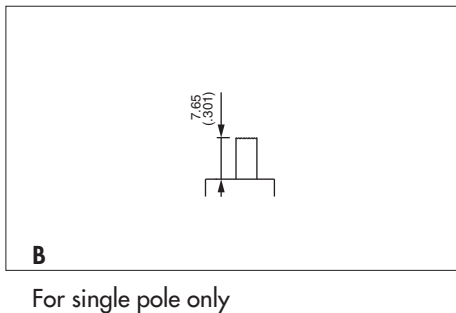
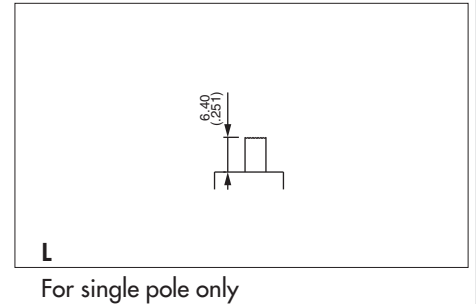
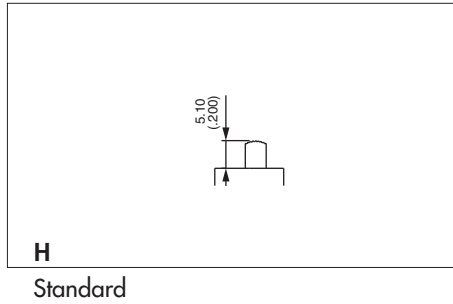
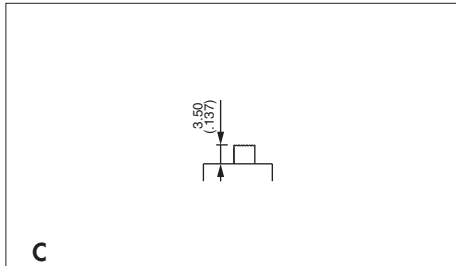

CONTACT AND TERMINAL MATERIALS

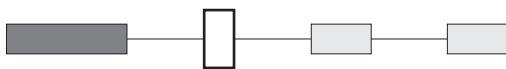

- 0** Brass, gold plated
- 1** Silver
- 2** Silver, gold plated
- 5** Special contact, lower rating, minimum quantity : consult factory

E

G series

Slide switches - telecom grade



SPECIAL OPTIONS 1

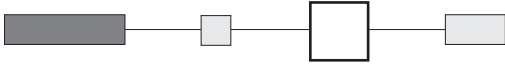

00 Standard switch as presented under "Model Structure"

10 Switch **without ground plate**
For right angle only (W0 and WW models)

11 10,35 mm (.407) long PC terminals

12 10,35 mm (.407) long PC terminals **without ground plate**

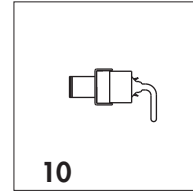

10

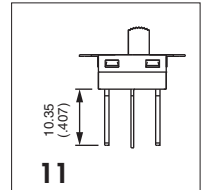

11

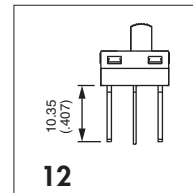

12

SPECIAL OPTIONS 2

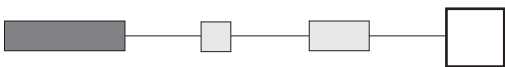

00 No epoxy seal

01 **Epoxy sealed** terminals
(compulsory on solder lug models)

10 **Extended terminals**
For vertical right angle (WW models)

11 **Extended terminals** as above, **with epoxy seal**

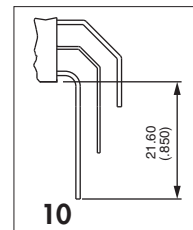

10

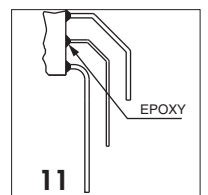

11

E